

Specifications

Display : LCD Display 1280x1024(SXGA)

Operation: Operated by RC-21 Controller
Power, Range, Gain, Shift, and User keys (4 items)

Transmission:

Pulse width 0.3/0.6/1.2/2.4ms
Output level 0 ~ 10 (10 steps)
Tx cycle: Ranging time multiplied by 2 ~ 5 times or synchronized by an external unit
※ Ranging time (sec) = Measurement range (m) / (Sound velocity setting (m/s) / 2)
Minimum Tx cycle 133(ms) ※ Depending on contents of the processing

Receiving: TVG Processing: 20logR(SV), 40logR(TS), Flat, CONV (Traditional way)
TVG Volume: 0.0 ~ 10.0 ※ Operative when CONV Mode
Displayed sensitivity: 0.0 ~ 10.0
Displayed bottom sensitivity: -10.0 ~ 10.0
※ Change of the sensitivity deeper than seabed

Display Functions:

Normal screen: Normal fish finder screen
Enlarged dual screen: Enlarged screen of normal screen or dual screen of bottom fixed of normal screen
A-scope screen: A-scope corresponding to normal screen and enlarged dual screen
Depth display: Display for bottom value of each fish finder
Navigation display: Display for longitude/latitude, vessel speed, and water temperatures
Net depth display: Display for water depth value of fish finder screen (Max. 4 units)
Water temp. display: Water temp. of ship bottom etc... displayed by water temp. from external device.
Fish size graph: Display for fish-size graph of selected area
※ Only when connecting with a split beam
Trace display: Display for a trace graph of selected area
※ Only when connecting with a split beam

Number of screen display:

Max. 5 displays (4 frequencies + frequency difference)

Scale : Meter, Fathom, Feet, Hiro

Range : 10 ~ 5000 (Meter Scale)

Original range: Arbitrary range value settings *10(scale) steps

Automatic bottom track: Auto range mode, auto shift mode

Shift : Variable within less than max. range in 1/5 steps

Display color: 16/64 colors

Color pattern: 8 types

Bottom line: White, black, ground color omission, OFF

Marker : minute, time, distance

Screen feed speed: 3, 2, 1, 1/2, 1/3 times

Screen feed direction: Normal (left direction), Invert (right direction)

Interference elimination:

4 types (weak, medium, strong, interpolation)

Discrimination: Horizontal discrimination 1 ~ 20

Vertical discrimination 1 ~ 20

Bottom level: Color display (16 or 64 steps)

Recording function:

Display: JPEG format, Resolution: 1280 x 1024

Raw data recording: Sonic format, compatible with KFC-3000

External interface:

Synchronized input/output (TTL plus/minus),
Navigation information input/output (Corresponding to NMEA0183),
Net depth (Sonic net finder or keying input)
[Bottom hardness data for Olex plotter](#)

Language: Japanese, English, Norwegian, Spanish, Turkey, Thai, Russian, Korean

Power supply capacity:

PRC-63 Processor Single phase: AC100V ~ AC220V±15% 60VA

SR-87 Tx/Rx Single phase: AC100V ~ AC220V(Switch)
±15% 200VA

Operational temperature:

I-133 Display : -5° ~ 45°

RC-21 remote controller: -5° ~ 45°

PRC-63 Processor : -5° ~ 45°

SR-87 Tx/Rx : -5° ~ 55°

Remarks: Try to no condensation and avoid water and salt air.

Dimensional outline drawing and Weight

I-133 Display

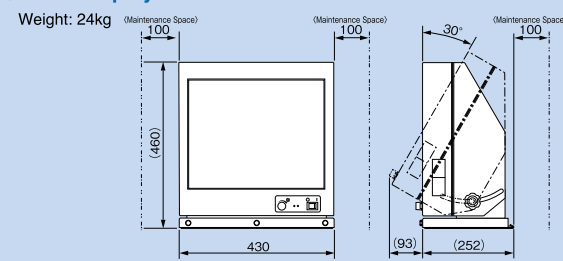

RC-21 Controller

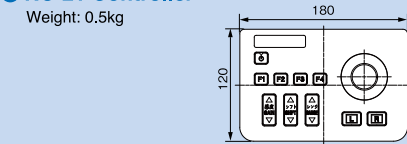

PRC-63 Processor

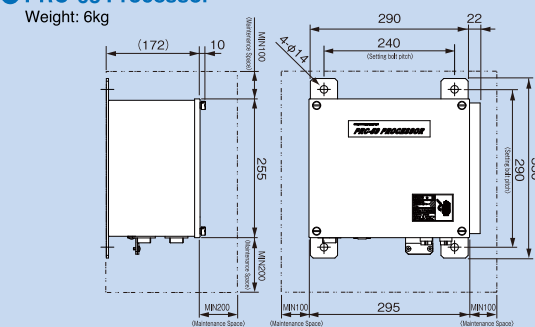

SR-87 Tx/Rx

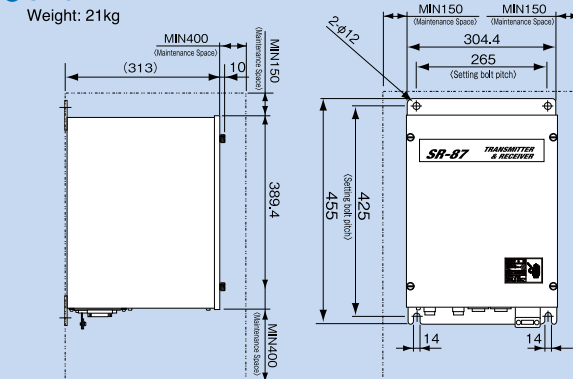

T-178 Transducer (38kHz) Weight: 27kg

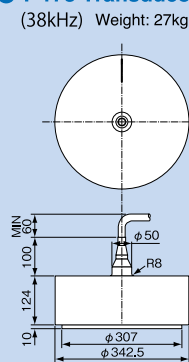

T-181 Transducer (70kHz) Weight: 20kg

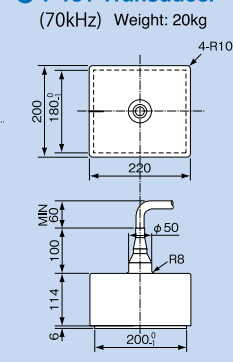

T-182 Transducer (120kHz) Weight: 8kg

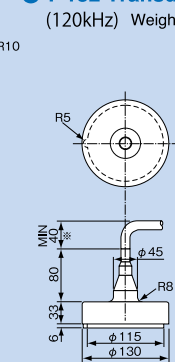

SONIC CORPORATION
SINCE 1948 KAIJO DENKI

Fish Sizing Echo Sounder

KSE-310

Sizing Echo Sounder with Split beam transducer

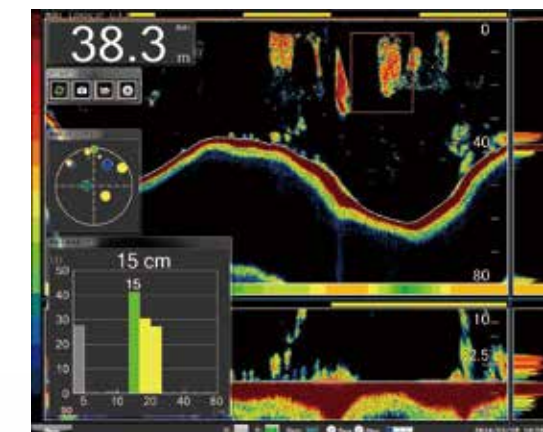

⚠ SAFETY PRECAUTION: Please be sure to read the Instruction Manual before operating.

● Specifications are subject to change without prior notice for development

SONIC CORPORATION

1-18-2, Akebonocho, Tachikawa, Tokyo Japan 190-0012

TEL: +81-42-512-5496 FAX: +81-42-595-9950

Email: info@u-sonic.co.jp URL: www.u-sonic.co.jp



New KSE series offers efficient fishing and resource management!

Main features

- Fish length graphs are more smoothly displayed in higher definition**
Higher definition is achieved by an increased data amount that's 1.5 times more than before, as well as by a reduced pulse width
- Operability is greatly improved through a dedicated controller**
- Multi-screen**
Up to five types of echograms can be simultaneously displayed
- A function to record raw data is available as a standard feature**
- Introduction of an ultra-high-precision digital TVG as leading-edge technology**
Improved interference elimination and image discrimination
- Frequency difference method**
This is effective for extracting the target fish school
※This feature is available on a system with two or more frequencies
- Dual Monitor Display**
Different frequency can be shown on each display separately
- Full HD Display**
Full HD Display is available.

Full HD Display

Wide Full HD Display available.

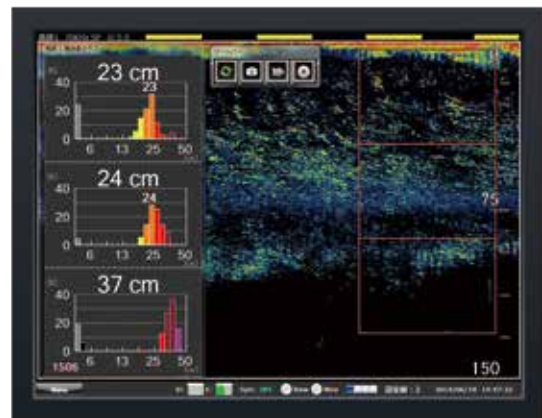

Raw data recording

To meet the requirements of users who wish to use this system not only for selective fishing and resource management but also for biomass evaluation, a new function to record raw data has been added. The data can be recorded with one click in a USB flash drive. In compatible with the KFC series, analysis software corresponding with Echoview* is required.



Recording setting screen

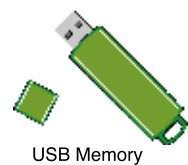

USB Memory

※Echoview is a registered trademark of Myriax Pty Ltd.

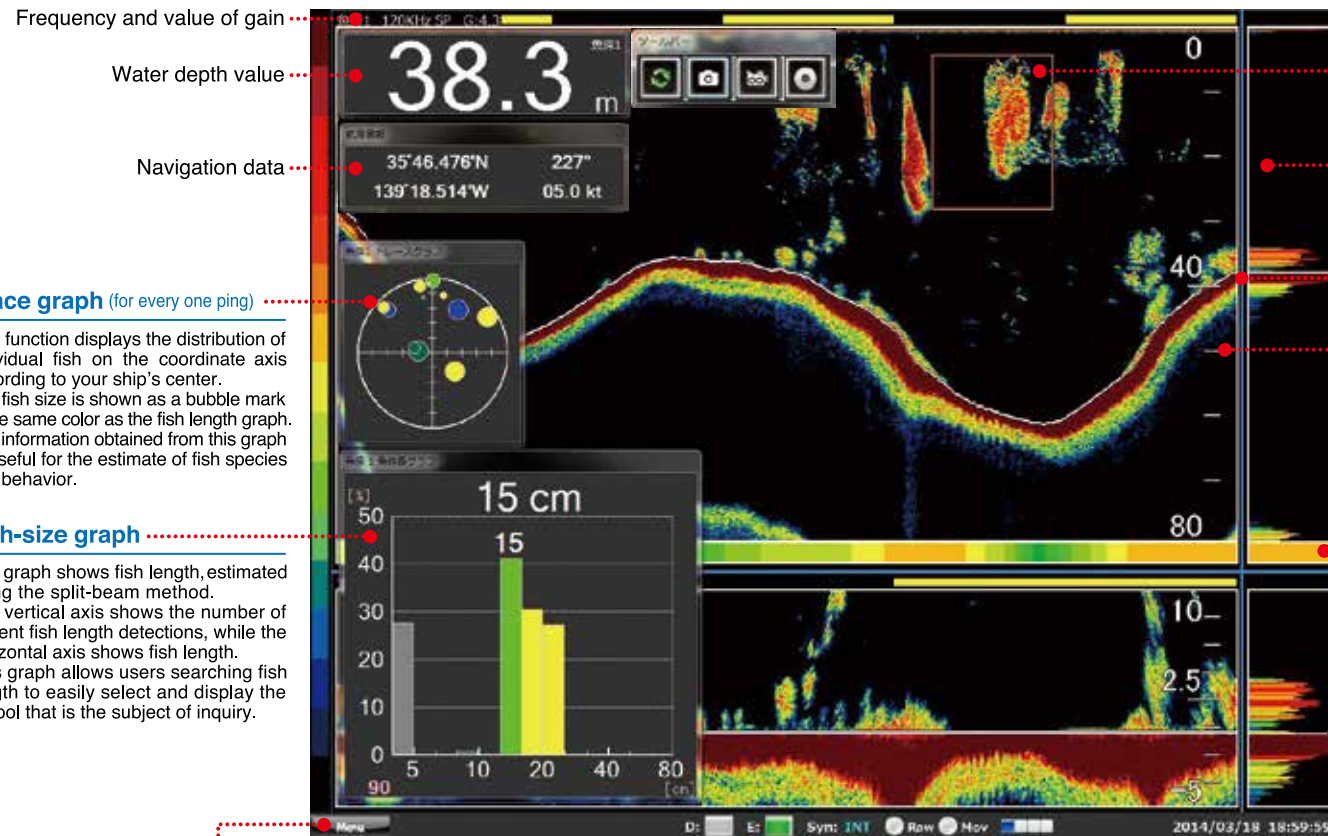

Trace graph (for every one ping)
This function displays the distribution of individual fish on the coordinate axis according to your ship's center. The fish size is shown as a bubble mark in the same color as the fish length graph. The information obtained from this graph is useful for the estimate of fish species and behavior.

Fish-size graph
The graph shows fish length, estimated using the split-beam method. The vertical axis shows the number of current fish length detections, while the horizontal axis shows fish length. This graph allows users searching fish length to easily select and display the school that is the subject of inquiry.

Menu button (Dropdown components)

The usage of the folder used for saving is displayed

Toolbar

Screens and continuous still images can be saved, and raw data can be recorded. These are stored in the USB memory in JPEG format so that they can be viewed on any computer

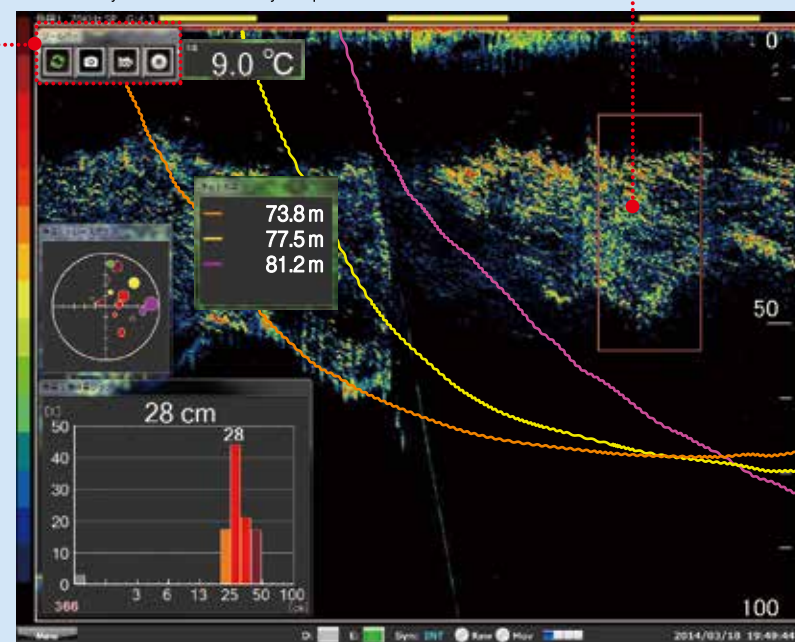

※Net depth of the above screen is an image taken from Sonic Net Finder, KNF-100 (three frequencies)

The fish length of the school within the range you selected can be measured. (There are three other ways available to select the ranges)

A Scope

Sea bottom (Displayed in solid white)

Scale

Sea bottom level

(The reflection strength of the sea bottom is shown)
The sea bottom level is color displayed based on the seabed integration result in addition to the underwater echogram.

Enlarged sea bottom display (Sea bottom fixed display)

Sea bottom

Dedicated controller (RC21)

Power key Arbitrarily-set and one-push button operation

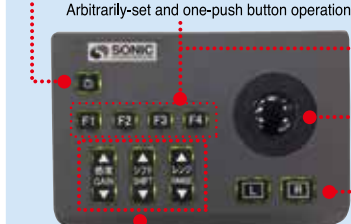

Gain/Shift/Range adjustment

Multi-screen

Max. 5-screen display

The size and position of each window can be changed freely

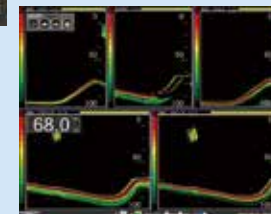

Dual Monitor Display

Dual Monitor of different frequency enables and enhances Skippers' ability to detect fish size more precisely.

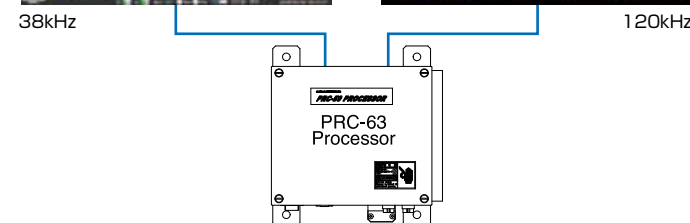
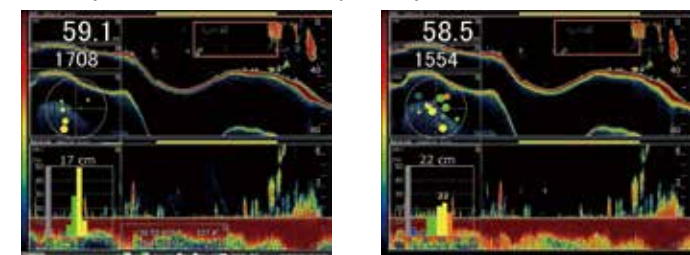

KSE-310 System Diagram

● Up to two display and controller units can be installed. Separate two monitors show different frequency pictures.

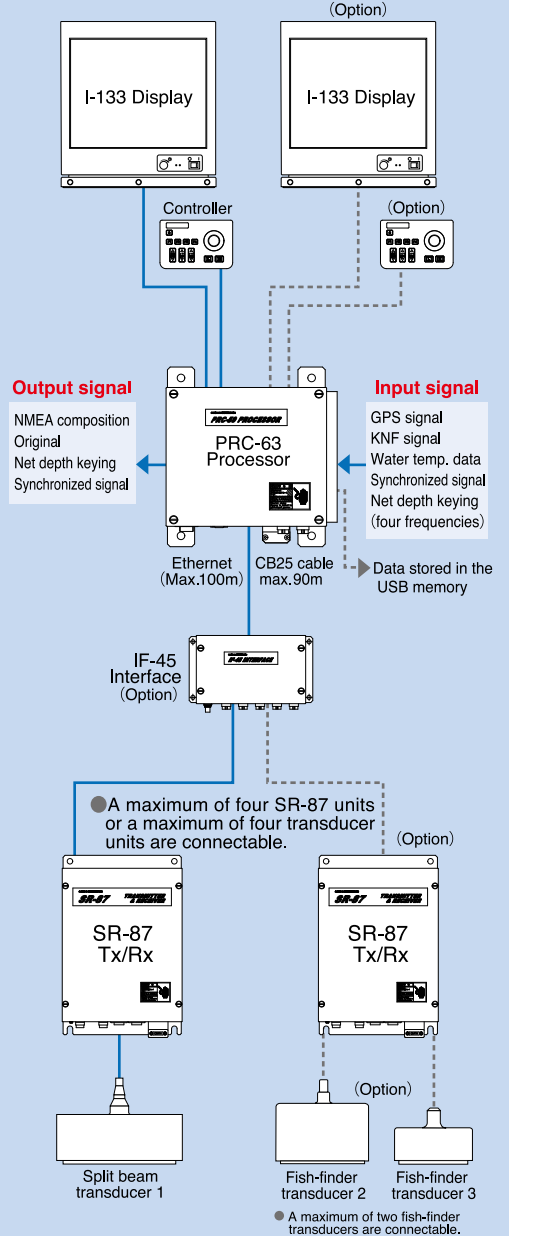

Fish Sizing Echo Sounder KSE-310

- Transducer: Split beam
- Beam width 8.5° x 8.5°(-3 dB, full angles)
- 38.0 kHz : T-178 transducer (Tx output 3 kW)
- 70.0 kHz : T-181 transducer (Tx output 3 kW)
- 120.0 kHz: T-182 transducer (Tx output 1.5 kW)

Color fish finder KCE-310

- Single beam transducer below is selectable. But fish-sizing measurement is not available.
- 15 kHz : T-105A Transducer (Tx output 2 kW)
- 24 kHz : T-51C Transducer (Tx output 2 kW)
- 50 kHz : T-51H Transducer (Tx output 2 kW)
- 75 kHz : T-51K Transducer (Tx output 2 kW)
- 200 kHz: T-105R Transducer (Tx output 2 kW)